

BP25



EN

ORIGINAL INSTRUCTIONS
DEW POINT SCANNER

 **TROTEC**

Table of contents

Notes regarding the instructions 2

Safety 2

Information about the device 4

Transport and storage 6

Operation 6

Maintenance and repair 7

Errors and faults 7

Disposal 7

Notes regarding the instructions

Symbols

 **Warning of electrical voltage**
This symbol indicates dangers to the life and health of persons due to electrical voltage.

 **Warning of laser radiation**
This symbol indicates dangers to the health of persons due to laser radiation.

 **Warning**
This signal word indicates a hazard with an average risk level which, if not avoided, can result in serious injury or death.

 **Caution**
This signal word indicates a hazard with a low risk level which, if not avoided, can result in minor or moderate injury.

Note
This signal word indicates important information (e.g. material damage), but does not indicate hazards.

 **Info**
Information marked with this symbol helps you to carry out your tasks quickly and safely.

 **Follow the manual**
Information marked with this symbol indicates that the instructions must be observed.

You can download the current version of the instructions and the EU declaration of conformity via the following link:



BP25



<https://hub.trotec.com/?id=42638>

Safety

Read this manual carefully before starting or using the device. Always store the manual in the immediate vicinity of the device or its site of use.

-  **Warning**
Read all safety warnings and all instructions. Failure to follow the warnings and instructions may result in electric shock, fire and/or serious injury.
Save all warnings and instructions for future reference.
- Do not use the device in potentially explosive rooms or areas and do not install it there.
 - Do not use the device in aggressive atmosphere.
 - Protect the device from permanent direct sunlight.
 - Do not remove any safety signs, stickers or labels from the device. Keep all safety signs, stickers and labels in legible condition.
 - Do not open the device.
 - Avoid looking directly into the laser beam.
 - Never point the laser beam at people or animals.
 - Never charge batteries that cannot be recharged.
 - Different types of batteries and new and used batteries must not be used together.
 - Insert the batteries into the battery compartment according to the correct polarity.
 - Remove discharged batteries from the device. Batteries contain materials hazardous to the environment. Dispose of the batteries according to the national regulations.
 - Remove the batteries from the device if you will not be using the device for a longer period of time.
 - Never short-circuit the supply terminal in the battery compartment!
 - Do not swallow batteries! If a battery is swallowed, it can cause severe internal burns within 2 hours! These burns can lead to death!

- If you think batteries might have been swallowed or otherwise entered the body, seek medical attention immediately!
- Keep new and used batteries and an open battery compartment away from children.
- Observe the operating conditions specified in the Technical data chapter.

Intended use

This device is exclusively intended for measuring temperature by means of an infrared sensor in the measuring range specified in the technical data. People who use this device must have read and understood the operating manual, especially the Safety chapter.

To use the device for its intended use, only use accessories and spare parts which have been approved by Trotec.

Foreseeable misuse

The device must not be pointed at people. Do not use the device in potentially explosive atmospheres, for measurements in liquids or at live parts. Trotec accepts no liability for damages resulting from improper use. In such a case, any warranty claims will be voided. Any unauthorised modifications, alterations or structural changes to the device are forbidden.

Personnel qualifications

People who use this device must:



- be aware of the dangers that occur when working with laser measuring devices.
- have read and understood the instructions, especially the Safety chapter.

Safety signs and labels on the device

Note

Do not remove any safety signs, stickers or labels from the device. Keep all safety signs, stickers and labels in legible condition.

The following safety signs and labels are attached to the device:

Warning sign	 Laser 2 
Meaning	The warning sign indicates that the device is equipped with a class 2 laser. Do not look directly into the laser beam or the opening from which the laser beam emerges!

Residual risks



Warning of electrical voltage

There is a risk of a short-circuit due to liquids penetrating the housing!

Do not immerse the device and the accessories in water. Make sure that no water or other liquids can enter the housing.



Warning of electrical voltage

Work on the electrical components must only be carried out by an authorised specialist company!



Warning of laser radiation

Laser class 2, P max.: < 1 mW, λ: 400-700 nm, EN 60825-1:2014

Do not look directly into the laser beam or the opening from which it emerges.

Never point the laser beam at people, animals or reflective surfaces. Even brief eye contact can lead to eye damage.

Examining the laser output aperture by use of optical instruments (e.g. magnifying glass, magnifiers and the like) entails the risk of eye damage.

When working with a laser of class 2, observe the national regulations on wearing eye protection.



Warning

Risk of suffocation!

Do not leave the packaging lying around. Children may use it as a dangerous toy.



Warning

The device is not a toy and does not belong in the hands of children.



Warning

Dangers can occur at the device when it is used by untrained people in an unprofessional or improper way! Observe the personnel qualifications!



Caution

Keep a sufficient distance from heat sources.

Note

To prevent damages to the device, do not expose it to extreme temperatures, extreme humidity or moisture.

Note

Do not use abrasive cleaners or solvents to clean the device.

Information about the device

Device description

The dew point scanner BP25 uses an infrared and humidity sensor to measure surface temperatures as well as air temperature and humidity without contact. An integrated dual laser serves for the determination of the measuring spot diameter.

The dew point is detected from these values. If the temperature in one part of the room is at or below the dew point, then the humidity in the air condenses. This can cause mould to form. Using the dew point scanner BP25 to measure the dew point, you can accurately pinpoint areas at risk of mould formation or poor insulation.

The risk of condensation forming at the measuring spot is indicated both by an acoustic alarm function and a changed display colour.

When not in use, an automatic switch-off saves the battery.

Measuring principle

The device measures the temperature by means of an infrared sensor. Important factors playing a role in the temperature measurement are the measuring spot diameter and the emissivity of the surface to be measured, which is set to the fixed value of 0.95 here.

Measuring spot

Observe the ratio of the distance to the measuring spot diameter. The larger the distance to the object, the larger the measuring spot diameter and hence, the less precise the measured result. The on-demand dual laser indicates the approximate diameter of the measuring spot, which is used by the device to calculate an average temperature. Consequently, it is a mere aiming aid and not intended for the actual temperature measurement. The smaller the measuring spot, the more precise is the measured result.

Device depiction

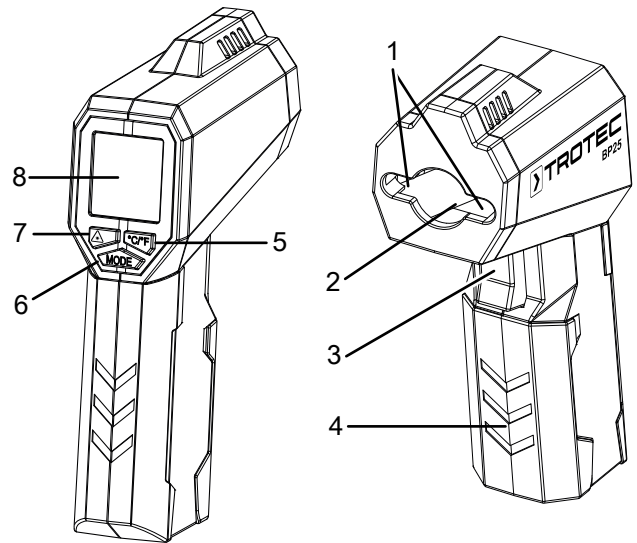

No.	Designation
1	Laser
2	Infrared sensor
3	Measurement button
4	Battery compartment with cover
5	°C / °F button
6	Mode button
7	Laser button
8	Display

DUAL-LASER

Distance : Spot = 20 : 1

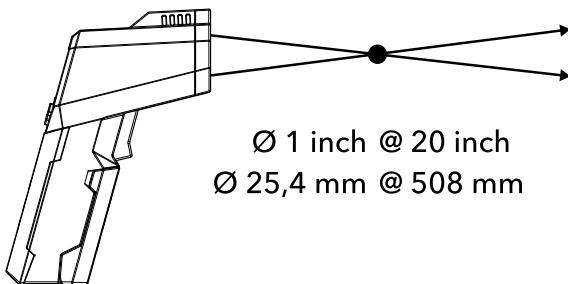

Display

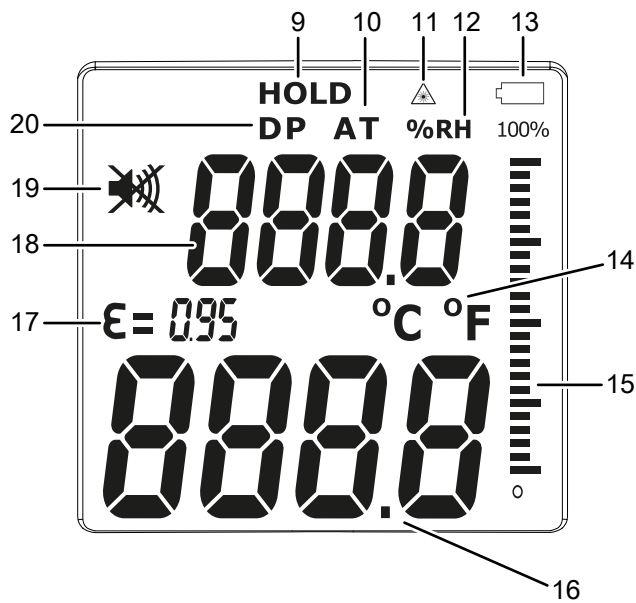

No.	Designation
9	<i>HOLD</i> indication
10	<i>AT</i> (ambient temperature) indication
11	<i>Laser</i> indication
12	<i>%RH</i> indication
13	Battery indication
14	Temperature unit indication
15	Scale for risk of condensation forming at the measuring spot
16	Measurement value display for temperature at the measuring spot
17	Emissivity
18	Measurement value display for dew point temperature, ambient temperature or relative humidity
19	Alarm tone on/off indication
20	<i>DP</i> (dew point) indication

Technical data

Parameter	Value
Model	BP25
Weight	163 g
Dimensions (length x width x height)	82 mm x 58 mm x 168 mm
Temperature measuring range	-50 °C to 260 °C (-58 °F to 500 °F)
Basic accuracy Temperature	-50 to 20 °C (-58 to 68 °F) ±3.5 °C 20 to 260 °C (68 to 500 °F) 1 % ±1.5 °C
Measuring range for relative humidity	0 to 100 % RH
Basic accuracy Relative humidity	±3.5 % (20 to 80 %)
Measuring range Dew point temperature	-30 to 100 °C (-22 to 212 °F)
Basic accuracy Dew point temperature	-30 to 100 °C (-22 to 212 °F) ±2.0 %
Resolution	0.1 °C / °F
Target display	Laser class II, 630 to 670 nm < 1 mW
Emissivity	0.95
Optical resolution	20:1 (D:S)
Smallest measuring spot	∅ 25.4 mm (distance 508 mm)
Spectral sensitivity	8 to 14 µm
Response time	< 150 ms
Operating temperature	0 °C to 50 °C (32 °F to 122 °F), 10 % to 90 % RH
Storage conditions	-10 °C to 60 °C, < 80 % RH
Power supply	9 V battery
Switch-off	After approx. 15 minutes of non-use in SCAN mode. After approx. 1 minute of non-use in HOLD mode.

Scope of delivery

- 1 x Dew point scanner BP25
- 1 x 9 V battery
- 1 x Device bag
- 1 x manual

Transport and storage

Note

If you store or transport the device improperly, the device may be damaged.
 Note the information regarding transport and storage of the device.

Transport

For transporting the device, use the bag included in the scope of delivery in order to protect the device from external influences.

Storage

When the device is not being used, observe the following storage conditions:

- dry and protected from frost and heat
- protected from dust and direct sunlight
- with a cover to protect it from invasive dust if necessary
- the storage temperature complies with the values specified in the Technical data
- Batteries are removed from the device

Operation

Inserting the battery

Note

Make sure that the surface of the device is dry and the device is switched off.

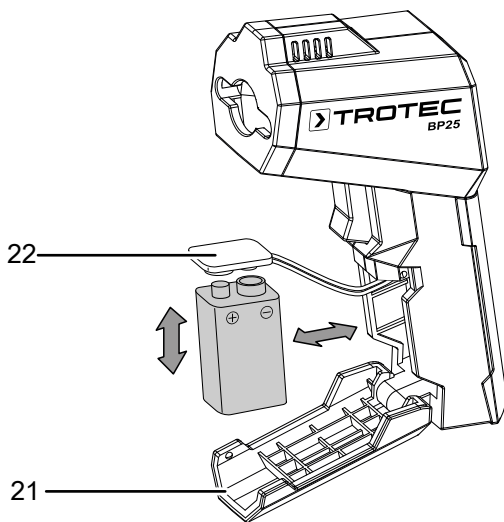

1. Open the battery compartment by folding open the cover (21) with your fingers.
2. Use the battery clip (22) to connect the new battery with correct polarity.
3. Insert the battery in the battery compartment.
4. Close the cover of the battery compartment.

Carrying out a measurement



Info

Please note that moving from a cold area to a warm area can lead to condensation forming on the device's circuit board. This physical and unavoidable effect can falsify the measurement. In this case, the display shows either no measured values or they are incorrect. Wait a few minutes until the device has become adjusted to the changed conditions before carrying out a measurement.

- Ensure that the surface to be measured is free of dust, dirt or similar substances.
 - To be able to gain exact measurement results on surfaces which reflect heavily, stick matt masking tape to the surface or apply matt black paint with a very high and known degree of emission.
 - Note the 20:1 ratio of the distance to the measuring spot size. The larger the distance to the object, the larger the measuring spot diameter and hence, the less precise the measured result.
1. Point the device at the object to be measured.
 2. Press the measurement button (3).
 - ⇒ The device switches on.
 - ⇒ The temperature of the measured object is shown on the measurement value display for temperature at the measuring spot (16). Depending on the settings, either the ambient temperature, the relative humidity or the dew point temperature are additionally displayed in the measurement value display (18).

You can determine the risk of condensation forming at the measuring spot by reading the scale (15) on the display (8), or based on the colour of the display illumination. Depending on the risk of condensation forming at the measuring spot, the display is illuminated in one of the following colours:

Display colour	Meaning
green	Surface temperature in normal range
orange	Surface temperature near dew point (borderline). When the alarm is enabled, a repetitive alarm tone is emitted.
red	Temperature of measured surface at or below dew point. ATTENTION: Risk of condensation forming! When the alarm is enabled, a constant alarm tone is emitted.

Switching the laser pointer on/off

Using the laser button (7) you can switch the laser pointer on or off.

1. Press the laser button (7).
 - ⇒ The laser symbol is displayed in the *Laser* indication (11).
 - ⇒ The laser (1) is switched on.
2. Press the laser button again to switch the laser off.
 - ⇒ The laser (1) is switched off.
 - ⇒ The laser symbol is no longer displayed in the *Laser* indication (11).



Info



The device memorizes the selected setting when switching off.

Changing the display °C / °F

1. Press the °C / °F button (5) to change between the units for the measured values.
 - ⇒ The selected unit is shown in the temperature unit indication (14) of the display (8).

Enabling / disabling the alarm

Press and hold the °C / °F button (5) for approx. three seconds to switch the alarm tone on or off.

1. Press and hold the °C / °F button (5) for approx. three seconds.
 - ⇒ An acoustic signal is emitted.
 - ⇒ The symbol  appears in the alarm tone indication (19).
 - ⇒ The alarm tone is switched on.
2. Press and hold the °C / °F button (5) for approx. three seconds once again.
 - ⇒ The symbol  appears in the alarm tone indication (19).
 - ⇒ The alarm tone is switched off.

Switching the device off

1. Press and hold the measurement button (3) for approx. three seconds in SCAN mode.
 - ⇒ The device switches off.

Maintenance and repair

Battery change

The battery is to be changed when the battery indication (13) flashes in the display (8) or the device can no longer be switched on. See chapter Operation.

Cleaning

Clean the device with a soft, damp and lint-free cloth. Make sure that no moisture enters the housing. Do not use any sprays, solvents, alcohol-based cleaning agents or abrasive cleaners, but only clean water to moisten the cloth.

Repair

Do not modify the device or install any spare parts. For repairs or device testing, contact the manufacturer.

Errors and faults

The device has been checked for proper functioning several times during production. If malfunctions occur nonetheless, check the device according to the following list.

The device does not switch on:

- Check the charging status of the battery. Change the battery, if required (see chapter Inserting the battery).
- Make sure that the battery is properly positioned. Check the polarity is correct.

Disposal

Always dispose of packing materials in an environmentally friendly manner and in accordance with the applicable local disposal regulations.



The icon with the crossed-out waste bin on waste electrical or electronic equipment is taken from Directive 2012/19/EU. It states that this device must not be disposed of with the household waste at the end of its life. You will find collection points for free return of waste electrical and electronic equipment in your vicinity. The addresses can be obtained from your municipality or local administration. You can also find out about other return options that apply for many EU countries on the website <https://hub.trotec.com/?id=45090>. Otherwise, please contact an official recycling centre for electronic and electrical equipment authorised for your country.

The separate collection of waste electrical and electronic equipment aims to enable the re-use, recycling and other forms of recovery of waste equipment as well as to prevent negative effects for the environment and human health caused by the disposal of hazardous substances potentially contained in the equipment.



In the European Union, batteries and accumulators must not be treated as domestic waste, but must be disposed of professionally in accordance with Directive 2006/66/EC of the European Parliament and of the Council of 6 September 2006 on batteries and accumulators. Please dispose of batteries and accumulators according to the relevant legal requirements.

Only for United Kingdom

According to Waste Electrical and Electronic Equipment Regulations 2013 (SI 2013/3113) (as amended) and the Waste Batteries and Accumulators Regulations 2009 (SI 2009/890) (as amended), devices that are no longer usable must be collected separately and disposed of in an environmentally friendly manner.

Trotec GmbH

Grebener Str. 7
D-52525 Heinsberg

☎ +49 2452 962-400

☎ +49 2452 962-200

✉ info@trotec.com

www.trotec.com