

EN

ORIGINAL INSTRUCTIONS
PYROMETER CONTROLLED
VIA SMARTPHONE



Table of contents

Notes regarding the instructions 2

Safety 2

Information about the device 4

Transport and storage 6

Operation 6

Maintenance and repair 15

Errors and faults 15

Disposal 16

Declaration of conformity 16

Notes regarding the instructions

Symbols



Warning of electrical voltage

This symbol indicates dangers to the life and health of persons due to electrical voltage.



Warning of laser radiation

This symbol indicates dangers to the health of persons due to laser radiation.



Warning

This signal word indicates a hazard with an average risk level which, if not avoided, can result in serious injury or death.



Caution

This signal word indicates a hazard with a low risk level which, if not avoided, can result in minor or moderate injury.

Note

This signal word indicates important information (e.g. material damage), but does not indicate hazards.



Info

Information marked with this symbol helps you to carry out your tasks quickly and safely.



Follow the manual

Information marked with this symbol indicates that the instructions must be observed.

You can download the current version of the instructions and the EU declaration of conformity via the following link:



BP21WP



<https://hub.trotec.com/?id=43341>

Safety

Read this manual carefully before starting or using the device. Always store the manual in the immediate vicinity of the device or its site of use.



Warning

Read all safety warnings and all instructions.

Failure to follow the warnings and instructions may result in electric shock, fire and/or serious injury.

Save all warnings and instructions for future reference.

- Do not use the device in potentially explosive rooms or areas and do not install it there.
- Do not use the device in aggressive atmosphere.
- Do not immerse the device in water. Do not allow liquids to penetrate into the device.
- The device may only be used in dry surroundings and must not be used in the rain or at a relative humidity exceeding the operating conditions.
- Protect the device from permanent direct sunlight.
- Do not expose the device to strong vibrations.
- Do not remove any safety signs, stickers or labels from the device. Keep all safety signs, stickers and labels in legible condition.
- Do not open the device.
- Avoid looking directly into the laser beam.
- Never point the laser beam at people or animals.
- Never charge batteries that cannot be recharged.
- Different types of batteries and new and used batteries must not be used together.
- Insert the batteries into the battery compartment according to the correct polarity.
- Remove discharged batteries from the device. Batteries contain materials hazardous to the environment. Dispose of the batteries according to the national regulations.
- Remove the batteries from the device if you will not be using the device for a longer period of time.

- Never short-circuit the supply terminal in the battery compartment!
- Do not swallow batteries! If a battery is swallowed, it can cause severe internal burns within 2 hours! These burns can lead to death!
- If you think batteries might have been swallowed or otherwise entered the body, seek medical attention immediately!
- Keep new and used batteries and an open battery compartment away from children.
- Observe the storage and operating conditions (see Technical data).

Intended use

Use this device in combination with a terminal device that is compatible with the installed Trotec MultiMeasure Mobile app.

Only use the device for temperature measurements by means of an infrared sensor within the measuring range specified in the technical data. Observe and comply with the technical data.

The Trotec MultiMeasure Mobile app on the terminal device is used for both operation and the evaluation of the measured values.

Data logged by the device can be displayed, saved or transmitted either numerically or in form of a chart.

To use the device for its intended use, only use accessories and spare parts which have been approved by Trotec.

Foreseeable misuse

The device must not be pointed at people. Do not use the device in potentially explosive atmospheres, for measurements in liquids or on live parts.

Radio waves may interfere with the operation of medical equipment and cause malfunctions. Do not use the device near medical equipment or within medical institutions.

Persons with pacemakers must observe a minimum distance of 20 cm between the pacemaker and the device.

Also do not use the device near automatically controlled systems such as alarm systems and automatic doors. Radio waves may interfere with the operation of such equipment and cause malfunctions. Make sure that no other devices are malfunctioning during the use of your device.

Any unauthorised changes, modifications or alterations to the device are forbidden.

Personnel qualifications

People who use this device must:

- be aware of the dangers that occur when working with laser measuring devices.
- have read and understood the instructions, especially the Safety chapter.

Safety signs and labels on the device

Note

Do not remove any safety signs, stickers or labels from the device. Keep all safety signs, stickers and labels in legible condition.

The following safety signs and labels are attached to the device:



Warning of magnetic field

Information marked with this symbol indicates dangers to the life and health of persons due to magnetic fields.



Disrupted operation or damage to pacemakers and implanted defibrillators caused by the device

This symbol indicates that the device must be kept away from pacemakers or implanted defibrillators.

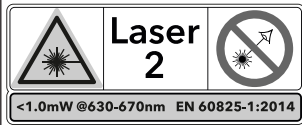
Warning sign	
Meaning	<p>The warning sign is located on the back of the device and indicates that the device is equipped with a class 2 laser.</p> <p>The power is less than 1.0 mW. The frequency range of the laser is 630 to 670 nm.</p> <p>Do not look directly into the laser beam or the opening from which the laser beam emerges!</p>

Residual risks



Warning of electrical voltage

There is a risk of a short-circuit due to liquids penetrating the housing!

Do not immerse the device and the accessories in water. Make sure that no water or other liquids can enter the housing.



Warning of electrical voltage

Work on the electrical components must only be carried out by an authorised specialist company!



Warning

Magnetic field!



The magnet attachment can affect pacemakers and implanted defibrillators!

Always keep a minimum distance of 20 cm between the device and pacemakers or implanted defibrillators. Persons with pacemakers or implanted defibrillators must not carry the device in their breast pocket.

**Warning****Risk of damages or data loss due to magnetic field!**

Do not store, carry or use the device in the vicinity of data storage media or electronic devices such as hard drives, television units, gas meters or credit cards! There is a risk of data loss or damages. If possible, keep the highest safety distance possible (at least 1 m).

**Warning of laser radiation****Laser class 2, P max.: < 1 mW, λ: 400-700 nm, EN 60825-1:2014**

Do not look directly into the laser beam or the opening from which it emerges.

Never point the laser beam at people, animals or reflective surfaces. Even brief eye contact can lead to eye damage.

Examining the laser output aperture by use of optical instruments (e.g. magnifying glass, magnifiers and the like) entails the risk of eye damage.

When working with a laser of class 2, observe the national regulations on wearing eye protection.

**Warning**

Risk of suffocation!

Do not leave the packaging lying around. Children may use it as a dangerous toy.

**Warning**

The device is not a toy and does not belong in the hands of children.

**Warning**

Dangers can occur at the device when it is used by untrained people in an unprofessional or improper way! Observe the personnel qualifications!

**Caution**

Keep a sufficient distance from heat sources.

Note

To prevent damages to the device, do not expose it to extreme temperatures, extreme humidity or moisture.

Note

Do not use abrasive cleaners or solvents to clean the device.

Information about the device**Device description**

Used in combination with Trotec's MultiMeasure Mobile app the pyrometer permits non-contact, infrared surface temperature measurements. The pyrometer comes equipped with an on-demand multi-point laser which does not serve for temperature measurements but is instead used as aiming aid for the surface to be measured.

In case of individual measurements, the measurement value display can be refreshed both via the app and by a brief actuation of the measurement button at the measuring device.

Apart from the hold function, the measuring device can indicate minimum, maximum and average values and carry out series measurements.

In the app you can specify MAX and MIN alarm thresholds for all parameters measured with the device.

In case of a matrix measurement the measured values can be displayed two-dimensionally (XY-diagram) with a background image or grid.

The measurement results can be displayed and saved on the terminal device either numerically or in form of a chart. Then, the measurement data can be sent in PDF or Excel format.

The app also includes a report generation function, an organiser function, one for customer management and further analysis options. Moreover, it is possible to share measurements and project data with colleagues in another subsidiary. If MultiMeasure Studio Professional is installed on a PC, you can even use report templates and ready-made text blocks for various fields of application to turn the data into professional reports.

Measuring spot

Observe the ratio of the distance (D) to the measuring spot diameter (S). The larger the distance to the object, the larger the measuring spot diameter and hence, the less precise the measured result. The device calculates an average temperature from all the temperatures in the measuring spot.

The sensor has a geometric resolution of 10:1 (D:S).

Emissivity

The degree of emission is used to describe the energy radiation characteristics of a material.

A material's emissivity depends on various factors:

- Material composition
- Surface condition
- Temperature

Most organic materials have an emissivity of 0.95. Metals or shiny materials come with a much lower value. The sensor operates with a fixed degree of emission of 0.95. During the measurement please bear in mind that highly reflective surfaces (e.g. metal, glass, ceramics) can falsify the measurement result.



Info

If you simultaneously use a thermohygrometer BC21WP that is also connected to the app, you can now adopt the dew point determined with it as alarm threshold for the pyrometer BP21WP so as to obtain the functionality of a dew point scanner. An acoustic alarm signal generated by the app will be emitted by the terminal device when the measured temperature values reach or fall below the dew point.

Device depiction

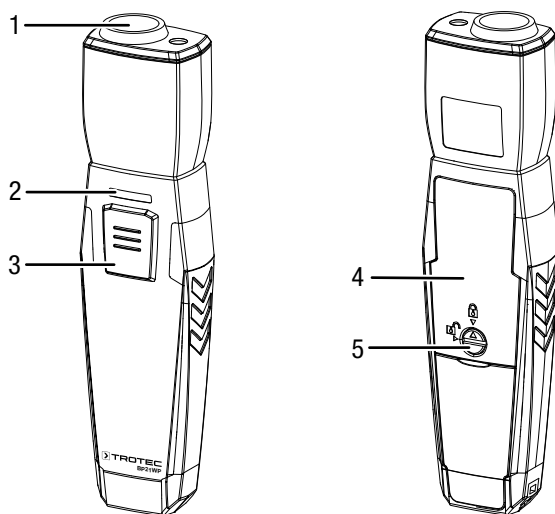

No.	Designation
1	Measuring sensor
2	LED
3	On / off / measurement button
4	Battery compartment with cover
5	Lock

Technical data

Parameter	Value
Model	BP21WP
Measuring range	-30 °C to 250 °C / -22 °F to 482 °F
Accuracy	± 3 °C (at > 0 °C) ± 2 °C / ± 2 % (at ≤ 0 °C)
Resolution	0.1 °C / 0.1 °F
Smallest measuring spot	∅ 12.7 mm (distance 254 mm)
Degree of emission	0.95
Response time	0.3 s
Spectral sensitivity	8-14 µm
Optical resolution (D:S)	10:1 (D:S)
Laser (target display)	
Class	2 (II)
Wavelength	630 – 670 nm
Power	1 mW
General technical data	
Bluetooth standard	Bluetooth 4.0, Low Energy
Bluetooth frequency range	2.4 GHz
Bluetooth max. transmission power	10 dBm
Radio range	approx. 10 m (depending on measuring environment)
Operating temperature	0 °C to 50 °C (32 °F to 122 °F), 10 % to 90 % RH
Storage temperature	-20 °C to 60 °C
Power supply	3 x 1.5 V batteries, type AAA
Device switch-off	after approx. 3 minutes without active Bluetooth connection
Protection type	IP40
Weight	110 g
Dimensions (length x width x height)	24.3 mm x 37 mm x 150.5 mm

Scope of delivery

- 1 x Device BP21WP
- 3 x 1.5 V battery AAA
- 1 x Wrist strap
- 1 x Quick guide

Transport and storage

Note

If you store or transport the device improperly, the device may be damaged.
 Note the information regarding transport and storage of the device.



Warning

Risk of damages or data loss due to magnetic field!

Do not store, carry or use the device in the vicinity of data storage media or electronic devices such as hard drives, television units, gas meters or credit cards!
 There is a risk of data loss or damages. If possible, keep the highest safety distance possible (at least 1 m).

Transport

When transporting the device, ensure dry conditions and protect the device from external influences e.g. by using a suitable bag.

Storage

When the device is not being used, observe the following storage conditions:

- dry and protected from frost and heat
- protected from dust and direct sunlight
- the storage temperature complies with the values specified in the Technical data
- Batteries are removed from the device

Operation

Inserting the batteries

Note

Make sure that the surface of the device is dry and the device is switched off.

1. Unlock the battery compartment by turning the lock (5) in a way that the arrow points towards the opened padlock icon.
2. Remove the cover from the battery compartment (4).
3. Insert the batteries (3 batteries of type AAA) into the battery compartment with correct polarity.
4. Put the cover back onto the battery compartment.

5. Lock the battery compartment by turning the lock (5) in a way that the arrow points towards the closed padlock icon.

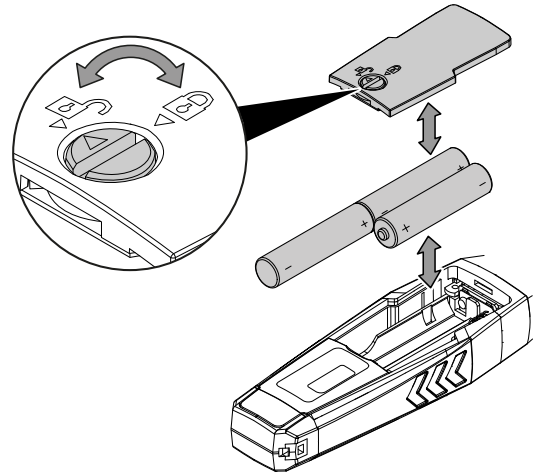

MultiMeasure Mobile app



Install the Trotec MultiMeasure Mobile app on the terminal device you want to use in combination with the device.

Info

Some of the app's functions require access to your location and an active Internet connection.

The app is available for download in the Google Play Store as well as in Apple's app store and via the following link:



<https://hub.trotec.com/?id=43083>

Info

Allow for an acclimatization period of about 10 minutes in the respective measuring environment prior to the appSensor's measuring operation.

Connecting the appSensor

Info

The app can simultaneously be connected to several different appSensors or appSensors of the same type and also record several measurements at the same time.

Proceed as follows to connect the appSensor to the terminal device:

- ✓ The Trotec MultiMeasure Mobile app is installed.
 - ✓ The Bluetooth function on your terminal device is activated.
1. Start the Trotec MultiMeasure Mobile app on the terminal device.
 2. Briefly actuate the *On / off / measurement* button (3) three times to switch on the appSensor.
 - ⇒ The LED (2) flashes yellow.
 3. Press the *Sensors* button (6) on the terminal device.
 - ⇒ The sensors overview opens.
 4. Press the *Refresh* button (7).
 - ⇒ If the scanning mode was not active before, the colour of the *Refresh* button (7) will change from grey to black. The terminal device now scans the surroundings for all available appSensors.
 5. Press the *Connect* button (8) to connect the desired sensor to the terminal device.
 - ⇒ The LED (2) flashes green.
 - ⇒ The appSensor is connected to the terminal device and starts measuring.
 - ⇒ The on-screen display changes to the continuous measurement.

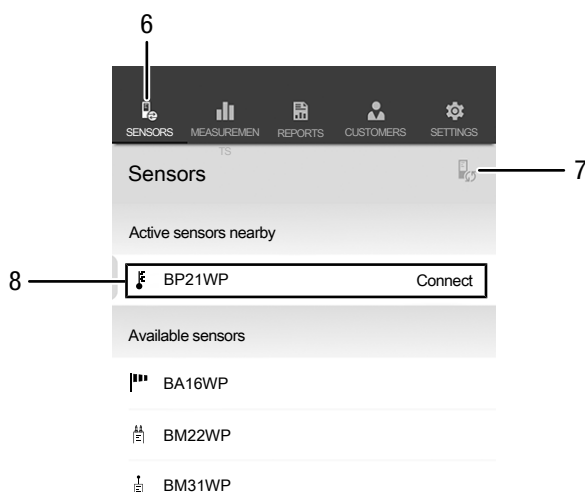

Switching the multi-point laser on / off

1. Briefly actuate the *On / off / measurement* button (3) at the appSensor twice to switch on the multi-point laser.
2. Briefly actuate the *On / off / measurement* button (3) at the appSensor two times again to switch the multi-point laser off.



Info

Please note that the multi-point laser does not serve for temperature measurements but is instead used as aiming aid for the surface to be measured.

Carrying out a measurement



Info

Note that moving from a cold area to a warm area can lead to condensation forming on the device's circuit board. This physical and unavoidable effect can falsify the measurement. In this case, the app will either display incorrect measured values or none at all. Wait a few minutes until the device has become adjusted to the changed conditions before carrying out a measurement.

1. Make sure that the surface to be measured is free of dust, dirt or similar substances.
2. To be able to gain exact measurement results on surfaces which reflect heavily, stick matt masking tape to the surface or apply matt black paint with a very high and known degree of emission.
3. Note the 10:1 ratio of the distance to the measuring spot diameter. For accurate measurements the measuring object should be at least twice as large as the measuring spot.

No.	Designation	Meaning
6	<i>Sensors</i> button	Opens the sensors overview.
7	<i>Refresh</i> button	Refreshes the list of sensors near the terminal device.
8	<i>Connect</i> button	Connects the displayed sensor to the terminal device.

Individual value measurement

When the appSensor has been successfully connected to the terminal device, an individual value measurement is started and the first determined value will be indicated.

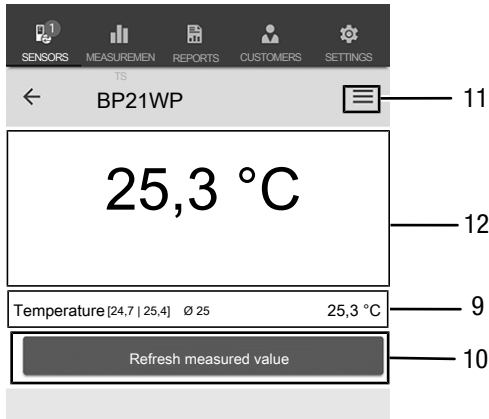

No.	Designation	Meaning
9	Numeric <i>value</i> display	Indicates the minimum, maximum and average values for the temperature as well as the current temperature value.
10	<i>Refresh measured value</i> button	Performs an individual measurement and refreshes the displayed values.
11	<i>Menu</i> button	Opens the menu for making settings for the current measurement.
12	Numeric <i>value</i> display	Indicates the most recently determined temperature value.

Refreshing the measured value

Proceed as follows to refresh the measured values in the individual value measurement mode:

1. Press the *Refresh measured value* button (10) on the terminal device.
 - ⇒ The appSensor determines the current measured value which is then displayed on the terminal device.
2. You can also press the *On / off / measurement* button (3) on the appSensor.
 - ⇒ The appSensor determines the current measured value which is then displayed on the terminal device.

Measurement settings

Proceed as follows to adjust the settings for the measurement:

1. Press the *Menu* button (11) or the free area below the measured value display.
 - ⇒ The context menu opens.
2. Adjust the settings as required.

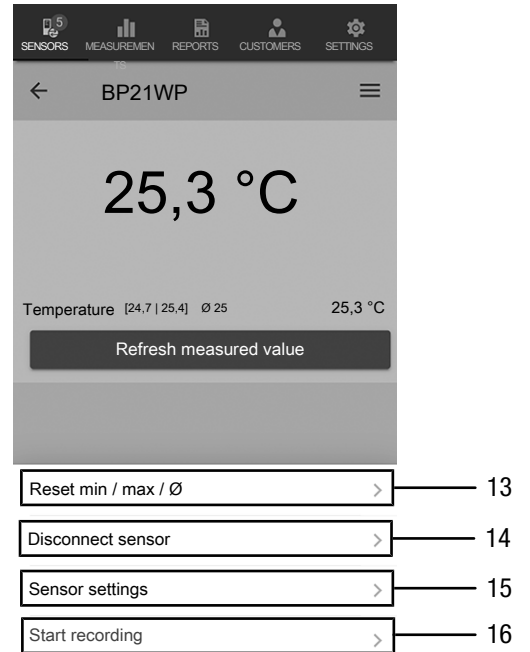

No.	Designation	Meaning
13	<i>Reset min / max / Ø</i> button	Deletes the determined values.
14	<i>Disconnect sensor</i> button	Disconnects the connected appSensor from the terminal device.
15	<i>Sensor settings</i> button	Opens the settings menu for the connected appSensor.
16	<i>Start recording</i> button	Starts a recording of the determined measured values for later evaluation.

Recording measured values

Proceed as follows to record measured values for later evaluation:

1. Press the *Menu* button (11).
⇒ The context menu opens.
2. Press the *Start recording* button (16).
⇒ A menu listing different measurement methods will be displayed:
 - Individual spot measurement without image
 - Individual spot measurement with image
 - Matrix measurement without background image
 - Matrix measurement with background image

If you select one of the measurement methods, you will be redirected to the respective submenu and the *REC* button (17) will be displayed instead of the *Menu* button (11).

Performing an individual spot measurement without image

The individual spot measurement without image allows you to record several individual measuring points. To do so, please proceed as follows:

1. Repeatedly press the *On / off / measurement* button (3) on the appSensor or the *Refresh measured value* button (10) on the terminal device until you have logged all the required measured values.

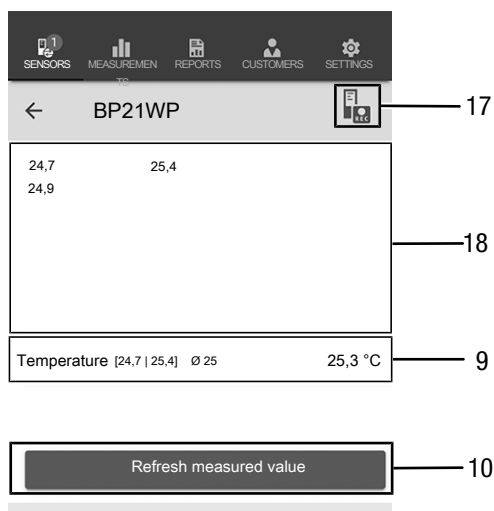

No.	Designation	Meaning
9	Numeric <i>value</i> display	Indicates the minimum, maximum and average values for the temperature as well as the current temperature value.
10	<i>Refresh measured value</i> button	Performs an individual measurement and refreshes the displayed values.
17	<i>REC</i> button	Opens the context menu for sensors.
18	Measurement series indication	Indicates the measured values of the measurement series in degrees Celsius.

Performing an individual spot measurement with image

If you have selected individual spot measurement with image, you will be prompted to choose whether you want to use a photo already saved in the mobile device's gallery or take a new one directly in the app. Choose an image section that best matches the measuring surface.

For measured value data logging please proceed as follows:

1. Tap the screen at the exact measuring location. The measured value will be displayed at this location.
2. You can also press the *On / off / measurement* button (3) on the appSensor.
⇒ The measured value will be displayed in a specified grid on the background image. Pressing the *Shift measuring point* button (20) allows you to adjust the position of the measuring points. By pressing the *Shift measuring point* button (20) once more you can return to the measuring mode.

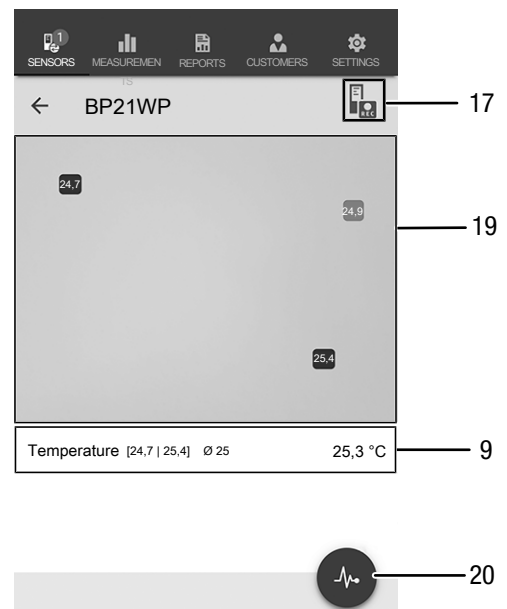

No.	Designation	Meaning
9	Numeric <i>value</i> display	Indicates the minimum, maximum and average values for the temperature as well as the current temperature value.
17	<i>REC</i> button	Opens the context menu for sensors.
19	Measuring field indication	Indicates the image of the measuring field and the values measured at the measuring points.
20	<i>Shift measuring point</i> button	Stops the measured value data logging and allows you to relocate the measuring points on the background image.

Performing a matrix measurement without background image

In case of a matrix measurement an entire series of measuring points is captured using a grid the size of which has to be selected.

1. Always start a matrix measurement in the top left corner (1st row, 1st column).
 - ⇒ The grid field to be measured flashes.
2. Perform the measurement in the flashing grid field.
3. Confirm the measured value by pressing the *Measured value data logging* button (22). You can reset a logged value by pressing *UNDO* (23). You can skip the indicated grid field and continue with the measurement in the next by pressing the *SKIP* button (24).
 - ⇒ The displayed measurement grid (21) moves on to the next line.
4. Perform the next measurement at the given point.
5. Press *NEW COLUMN* (25) when you have completed the measurements of all lines in one column so as to move on to the next.

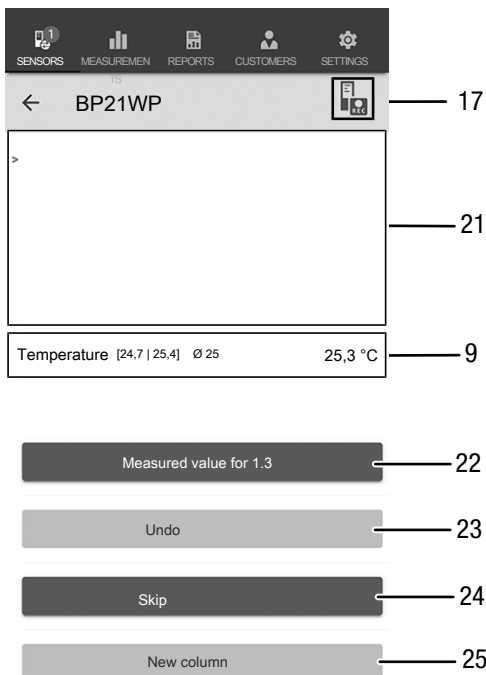

No.	Designation	Meaning
9	Numeric <i>value</i> display	Indicates the minimum, maximum and average values for the temperature as well as the current temperature value.
17	<i>REC</i> button	Opens the context menu for sensors.
21	Measuring field with grid	Indicates the measurement grid of the measuring field (grid field to be measured flashes red).
22	<i>Measured value data logging</i> button	Saves the measured value for the flashing grid field.

No.	Designation	Meaning
23	<i>UNDO</i> button	Deletes the saved measured value for the respective grid field.
24	<i>SKIP</i> button	Skips the grid field flashing red and moves on to the next grid field.
25	<i>NEW COLUMN</i> button	Starts a new column.

Performing a matrix measurement with background image

If you select a matrix measurement with background image, you will be prompted to choose whether you want to use a photo already saved in the mobile device's gallery or take a new one directly in the app. Choose an image section that best matches the measuring surface. You will then reach the settings menu for the measurement grid (21).

1. Adjust the grid's number of columns and lines by use of the slider (26).
2. Confirm the settings for the grid by pressing *Use* (27).

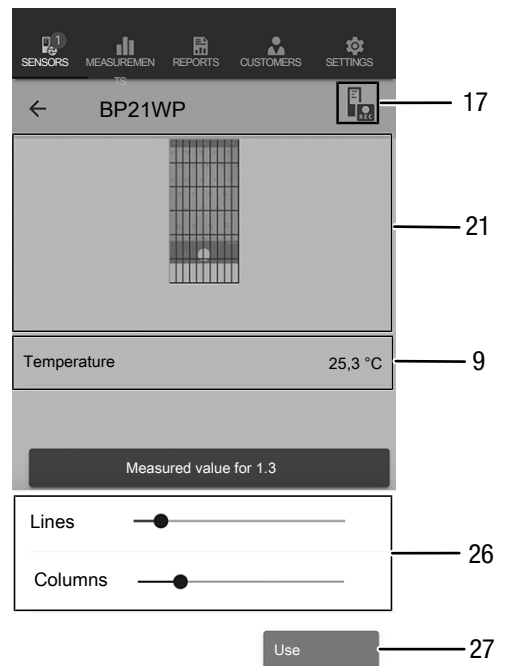

No.	Designation	Meaning
9	Numeric <i>value</i> display	Indicates the minimum, maximum and average values for the temperature as well as the current temperature value.
17	<i>REC</i> button	Opens the context menu for sensors.
21	Measuring field with grid	Indicates the measurement grid of the measuring field.
26	Slider	Changes the grid's number of columns and lines.
27	<i>Use</i> button	Confirms the grid settings and leads to the measurement menu.

Then start to carry out the measurements.

1. Always start a matrix measurement in the top left corner (1st row, 1st column).
 - ⇒ The grid field to be measured flashes.
2. Perform the measurement in the flashing grid field.
3. Confirm the measured value by pressing the *Measured value data logging* button (22). You can reset a logged value by pressing *UNDO* (23). You can skip the indicated grid field and continue with the measurement in the next by pressing the *SKIP* button (24).
 - ⇒ The displayed measurement grid (21) moves on to the next line.
4. Perform the next measurement at the given point.

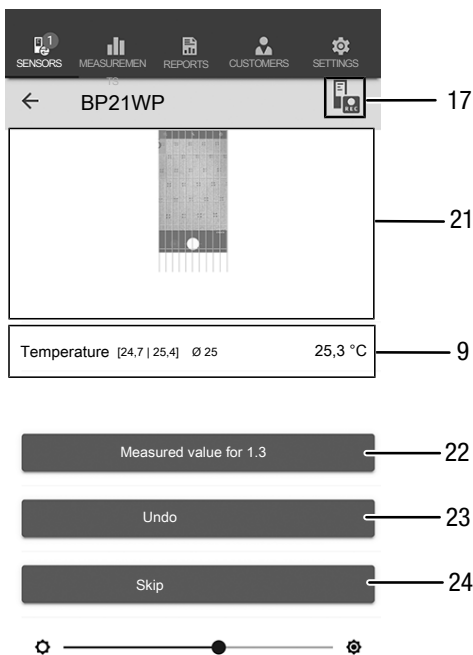

Stopping a recording

Proceed as follows to stop recording the measured values:

1. Press the *REC* button (17).
 - ⇒ The context menu for sensors opens.
2. Press the *Stop recording* button (28).
 - ⇒ The context menu for saving the recording opens.
3. You can optionally save, discard or resume the measurement.

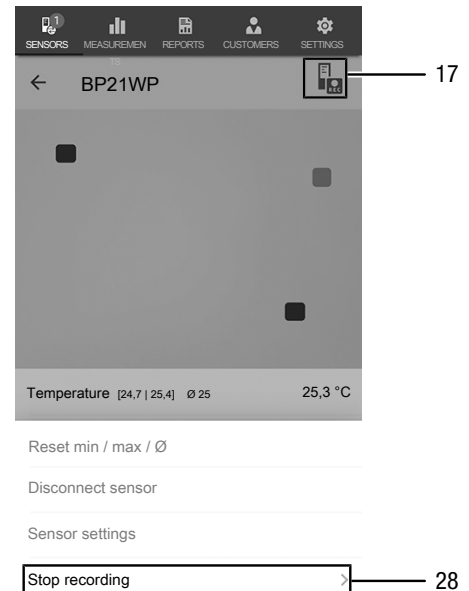

No.	Designation	Meaning
17	<i>REC</i> button	Opens the sensor settings menu.
28	<i>Stop recording</i> button	Stops the current recording of measured values. Opens the submenu for saving recordings.



Info

By use of the slider you can optionally bring out either the background image or the grid.

No.	Designation	Meaning
9	Numeric <i>value</i> display	Indicates the minimum, maximum and average values for the temperature as well as the current temperature value.
17	<i>REC</i> button	Opens the context menu for sensors.
21	Measuring field with grid	Indicates the measurement grid of the measuring field (grid field to be measured flashes red).
22	<i>Measured value data logging</i> button	Saves the measured value for the flashing grid field.
23	<i>UNDO</i> button	Deletes the saved measured value for the respective grid field.
24	<i>SKIP</i> button	Skips the grid field flashing red and moves on to the next grid field.

Saving a recording

Proceed as follows to save the recorded measured values:

1. Press the *Save* button (29) to save the recorded measured values on the terminal device.
⇒ The input mask for logging the recorded data opens.
2. Enter all the data relevant for an unambiguous assignment, then save the recording.
⇒ The recording will be saved on the terminal device.

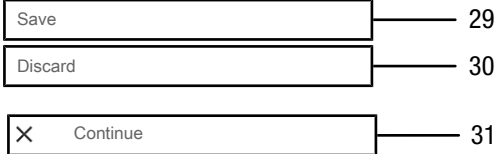
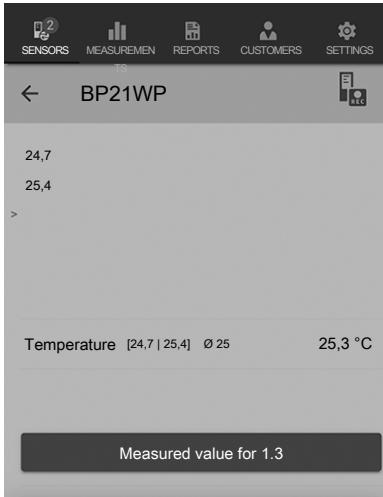

No.	Designation	Meaning
29	<i>Save</i> button	Stops the current recording of measured values. Opens the input mask for logging recording data.
30	<i>Discard</i> button	Stops the current recording of measured values. Discards the recorded measured values.
31	<i>Continue</i> button	Resumes the recording of the measured values without saving.

Analysing measurements

Proceed as follows to call up the saved measurements:

1. Press the *MEASUREMENTS* button (32).
⇒ An overview of already saved measurements will be displayed.
2. Press the *Display measurement* button (34) for the desired measurement to be indicated.
⇒ A context menu for the selected measurement opens.

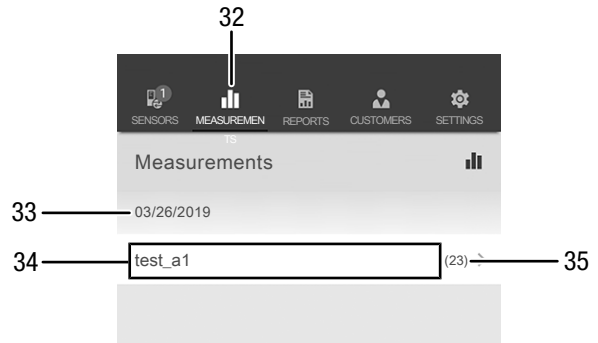

No.	Designation	Meaning
32	<i>MEASUREMENTS</i> button	Opens the overview of saved measurements.
33	Indication of the <i>date of the measurement</i>	Indicates the date on which the measurement was recorded.
34	<i>Display measurement</i> button	Opens the context menu for the selected measurement.
35	Indication of the <i>number of measured values</i>	Indicates the number of individual measured values constituting the saved measurement.

The following functions can be called up in the context menu of the selected measurement:

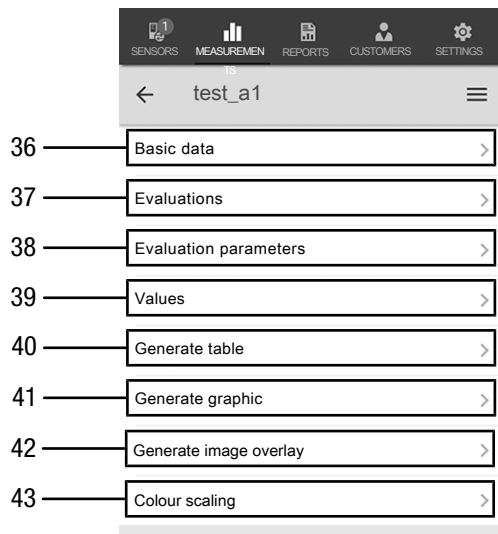

No.	Designation	Meaning
36	<i>Basic data</i> button	Opens an overview of the data saved for the measurement.
37	<i>Evaluations</i> button	Opens an overview of the evaluations generated for the measurement (graphics and tables).
38	<i>Evaluation parameters</i> button	Opens a menu to select and deselect individual evaluation parameters.
39	<i>Values</i> button	Opens a tabular overview of all logged values for the measurement.
40	<i>Generate table</i> button	Creates a table containing the logged values of the measurement and saves it as a *.CSV file.
41	<i>Generate graphic</i> button	Creates a graphic representation of the logged values and saves it as a *.PNG file.
42	<i>Generate image overlay</i> button	Combines a background image with the coloured representation of the measured moisture values.
43	<i>Colour scaling</i> button	Allows you to adjust the colour display of the measured moisture values.

Generating a report

The reports generated in the MultiMeasure Mobile app are short reports providing a fast and simple documentation. Proceed as follows to generate a new report:

1. Press the *REPORTS* button (44).
⇒ The reports overview opens.
2. Press the *New report* button (45) to create a new report.
⇒ An input mask for entering all the relevant information opens.
3. Enter the information via the input mask and save the data.

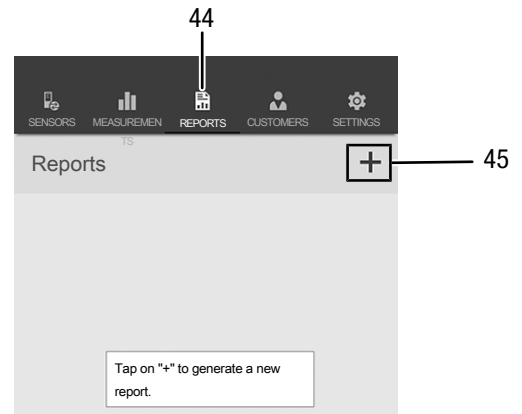

No.	Designation	Meaning
44	<i>REPORTS</i> button	Opens the overview of saved reports.
45	<i>New report</i> button	Creates a new report and opens the input mask.

Info

The customer can acknowledge the report directly in the integrated signature field.

Calling up a report

Proceed as follows to call up a created report:

1. Press the *REPORTS* button (44).
⇒ The reports overview opens.
2. Press the corresponding button (46) to display the desired report.
⇒ An input mask opens in which you can view and edit all the information.

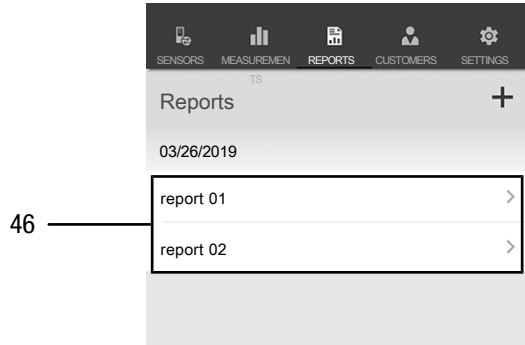

No.	Designation	Meaning
46	Display REPORT button	Opens the selected report.

Creating a new customer

Proceed as follows to create a new customer:

1. Press the *CUSTOMERS* button (47).
⇒ The customers overview opens.
2. Press the *New customer* button (48) to create a new customer.
⇒ An input mask for entering all the relevant information opens.
3. Enter the information via the input mask and save the data.
4. Alternatively, you can also import existing contacts from the phone book of the terminal device.

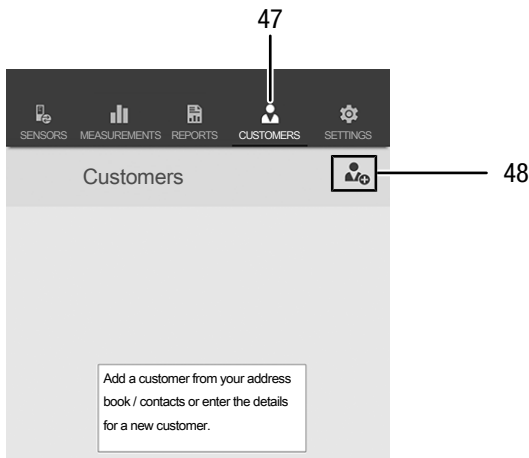

Info

You can perform a new measurement directly from the input mask.

Calling up customers

Proceed as follows to call up an already created customer:

1. Press the *CUSTOMERS* button (47).
⇒ The customers overview opens.
2. Press the corresponding button (49) to display the desired customer's details.
⇒ An input mask opens in which you can view and edit all the information for the selected customer as well as directly start a new measurement.
⇒ The *New customer* button (48) changes. In this menu it can be used to delete the selected customer data record.

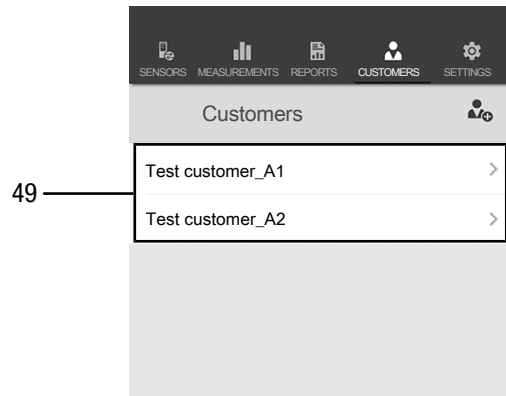

App settings

Proceed as follows to make settings in the Trotec MultiMeasure Mobile app:

1. Press the *settings* button (50).
⇒ The settings menu opens.
2. Adjust the settings as required.

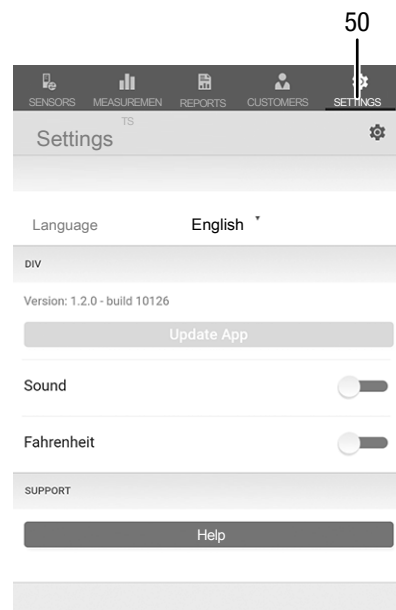

appSensor settings

Proceed as follows to adjust the settings for the appSensor:

1. Press the *Sensors* button (6).
 - ⇒ A list of connected and available sensors will be displayed.
2. Select the line with the appSensor the settings of which you want do adjust and swipe right at the yellow marking.
3. Confirm your input.
 - ⇒ The sensor menu opens.
4. Alternatively, you can press the *Sensors* button (6).
5. Press the *Menu* button (11).
 - ⇒ The context menu opens.
6. Press the *Sensor settings* button (15).
 - ⇒ The sensor menu opens.

Disconnecting an appSensor

Proceed as follows to disconnect an appSensor from the terminal device:

1. Press the *SENSORS* button (6).
 - ⇒ A list of connected and available sensors will be displayed.
2. Select the line with the appSensor to be disconnected and swipe left at the red marking.
3. Confirm your input.
 - ⇒ The appSensor is now disconnected from the terminal device and can be switched off.
4. Alternatively, you can press the *Menu* button (11).
 - ⇒ The context menu opens.
5. Press the *Disconnect sensor* button (14).
6. Confirm your input.
 - ⇒ The appSensor is now disconnected from the terminal device and can be switched off.

Switching off an appSensor

Info

Always terminate the connection between appSensor and app before you switch off the appSensor.

Proceed as follows to switch off an appSensor:

1. Press and hold the *On / off / measurement* button (3) for approx. 3 seconds.
 - ⇒ The LED (2) on the appSensor goes out.
 - ⇒ The appSensor is switched off.
2. You may now exit the Trotec MultiMeasure Mobile app on the terminal device.

Maintenance and repair

Battery change

A battery change is required when the LED at the device flashes red or the device can no longer be switched on. See chapter Operation.

Cleaning

Clean the device with a soft, damp and lint-free cloth. Make sure that no moisture enters the housing. Do not use any sprays, solvents, alcohol-based cleaning agents or abrasive cleaners, but only clean water to moisten the cloth.

Repair

Do not modify the device or install any spare parts. For repairs or device testing, contact the manufacturer.

Errors and faults

The device has been checked for proper functioning several times during production. If malfunctions occur nonetheless, check the device according to the following list.

Bluetooth connection is terminated or interrupted

- Check whether the LED at the appSensor flashes green. If so, briefly switch it off completely, then turn it back on. Establish a new connection to the terminal device.
- Check the battery voltage and insert new or freshly charged batteries, if required.
- Does the distance between appSensor and terminal device exceed the appSensor's radio range (see chapter *Technical data*) or are there any solid building parts (walls, pillars etc.) situated between appSensor and terminal device? Shorten the distance between the two devices and ensure a direct line of sight.

The sensor cannot be connected to the terminal device although it is displayed there.

- Check the Bluetooth settings of your terminal device. A possible reason for this could be special, manufacturer-specific settings relating to an improved location accuracy. Enable these settings, then try to establish a connection to the sensor again.

Further information and assistance regarding the used sensor type will be provided in the MultiMeasure Mobile app via the menu item Settings => *Help*. Selecting the menu item *Help* opens a link to the app's help page. You can open a drop-down menu with numerous support entries from the *Table of contents*. Optionally, you can also scroll through the entire help page and thoroughly acquaint yourself with the individual help topics.

Disposal

Always dispose of packing materials in an environmentally friendly manner and in accordance with the applicable local disposal regulations.



The icon with the crossed-out waste bin on waste electrical or electronic equipment is taken from Directive 2012/19/EU. It states that this device must not be disposed of with the household waste at the end of its life. You will find collection points for free return of waste electrical and electronic equipment in your vicinity. The addresses can be obtained from your municipality or local administration. You can also find out about other return options that apply for many EU countries on the website <https://hub.trotec.com/?id=45090>. Otherwise, please contact an official recycling centre for electronic and electrical equipment authorised for your country.

The separate collection of waste electrical and electronic equipment aims to enable the re-use, recycling and other forms of recovery of waste equipment as well as to prevent negative effects for the environment and human health caused by the disposal of hazardous substances potentially contained in the equipment.



In the European Union, batteries and accumulators must not be treated as domestic waste, but must be disposed of professionally in accordance with Directive 2006/66/EC of the European Parliament and of the Council of 6 September 2006 on batteries and accumulators. Please dispose of batteries and accumulators according to the relevant legal requirements.

Only for United Kingdom

According to Waste Electrical and Electronic Equipment Regulations 2013 (SI 2013/3113) (as amended) and the Waste Batteries and Accumulators Regulations 2009 (SI 2009/890) (as amended), devices that are no longer usable must be collected separately and disposed of in an environmentally friendly manner.

Declaration of conformity

We – Trotec GmbH – declare in sole responsibility that the product designated below was developed, constructed and produced in compliance with the requirements of the EU Radio Equipment Directive in the version 2014/53/EU.

Product model / Product: BP21WP
Product type: pyrometer controlled via smartphone
Year of manufacture as of: 2019

Relevant EU directives:

- 2001/95/EC
- 2014/30/EU

Applied harmonised standards:

- EN 300 328 V2.2.2

Applied national standards and technical specifications:

- EN 301 489-1 Draft Version 2.2.0:2017-03
- EN 301 489-17 Draft Version 3.2.0:2017-03
- EN 61010-1:2010
- EN 61326-1:2013
- EN 62479:2010

Manufacturer and name of the authorised representative of the technical documentation:

Trotec GmbH
Grebbeener Straße 7, D-52525 Heinsberg
Phone: +49 2452 962-400
E-mail: info@trotec.de

Place and date of issue:
Heinsberg, 17.02.2023

Joachim Ludwig, Managing Director

Trotec GmbH

Grebener Str. 7
D-52525 Heinsberg

☎ +49 2452 962-400

☎ +49 2452 962-200

✉ info@trotec.com

www.trotec.com