

EN

ORIGINAL INSTRUCTIONS
THERMOHYGROMETER



Table of contents

Notes regarding the instructions 2

Safety 2

Information about the device 4

Transport and storage 5

Operation 5

Maintenance and repair 6

Disposal 7

Notes regarding the instructions

Symbols

 **Warning of electrical voltage**
This symbol indicates dangers to the life and health of persons due to electrical voltage.

 **Warning**
This signal word indicates a hazard with an average risk level which, if not avoided, can result in serious injury or death.

 **Caution**
This signal word indicates a hazard with a low risk level which, if not avoided, can result in minor or moderate injury.

Note
This signal word indicates important information (e.g. material damage), but does not indicate hazards.

 **Info**
Information marked with this symbol helps you to carry out your tasks quickly and safely.

 **Follow the manual**
Information marked with this symbol indicates that the instructions must be observed.

You can download the current version of the instructions and the EU declaration of conformity via the following link:



BC21



<https://hub.trotec.com/?id=43335>

Safety

Read this manual carefully before starting or using the device. Always store the manual in the immediate vicinity of the device or its site of use.

-  **Warning**
Read all safety warnings and all instructions. Failure to follow the warnings and instructions may result in electric shock, fire and/or serious injury.
Save all warnings and instructions for future reference.
- Do not use the device in potentially explosive rooms or areas and do not install it there.
 - Do not use the device in aggressive atmosphere.
 - Do not immerse the device in water. Do not allow liquids to penetrate into the device.
 - The device may only be used in dry surroundings and must not be used in the rain or at a relative humidity exceeding the operating conditions.
 - Protect the device from permanent direct sunlight.
 - Do not expose the device to strong vibrations.
 - Do not remove any safety signs, stickers or labels from the device. Keep all safety signs, stickers and labels in legible condition.
 - Do not open the device.
 - Never charge batteries that cannot be recharged.
 - Different types of batteries and new and used batteries must not be used together.
 - Insert the batteries into the battery compartment according to the correct polarity.
 - Remove discharged batteries from the device. Batteries contain materials hazardous to the environment. Dispose of the batteries according to the national regulations.
 - Remove the batteries from the device if you will not be using the device for a longer period of time.
 - Never short-circuit the supply terminal in the battery compartment!

- Do not swallow batteries! If a battery is swallowed, it can cause severe internal burns within 2 hours! These burns can lead to death!
- If you think batteries might have been swallowed or otherwise entered the body, seek medical attention immediately!
- Keep new and used batteries and an open battery compartment away from children.
- Observe the storage and operating conditions (see Technical data).

Intended use

Only use the device for indoor temperature and humidity measurements within the measuring range specified in the technical data. Observe and comply with the technical data.

To use the device for its intended use, only use accessories and spare parts which have been approved by Trotec.

Foreseeable misuse

Do not use the device in potentially explosive atmospheres, for measurements in liquids or at live parts. Trotec accepts no liability for damages resulting from improper use. In such a case, any warranty claims will be voided. Any unauthorised modifications, alterations or structural changes to the device are forbidden.

Personnel qualifications

People who use this device must:

- have read and understood the instructions, especially the Safety chapter.

Residual risks



Warning of electrical voltage

There is a risk of a short-circuit due to liquids penetrating the housing!

Do not immerse the device and the accessories in water. Make sure that no water or other liquids can enter the housing.



Warning of electrical voltage

Work on the electrical components must only be carried out by an authorised specialist company!



Warning

Risk of suffocation!

Do not leave the packaging lying around. Children may use it as a dangerous toy.



Warning

The device is not a toy and does not belong in the hands of children.



Warning

Dangers can occur at the device when it is used by untrained people in an unprofessional or improper way! Observe the personnel qualifications!



Caution

Keep a sufficient distance from heat sources.

Note

To prevent damages to the device, do not expose it to extreme temperatures, extreme humidity or moisture.

Note

Do not use abrasive cleaners or solvents to clean the device.

Information about the device

Device description

The thermohygrometer BC21 can be used to determine the air, dew point and wet-bulb temperature as well as the humidity level of indoor areas.

For assessing the measurements, a Max / Min function (maximum and minimum value) and a Hold function for freezing the currently measured value are also available.

When not in use, an automatic switch-off saves the battery.

Device depiction

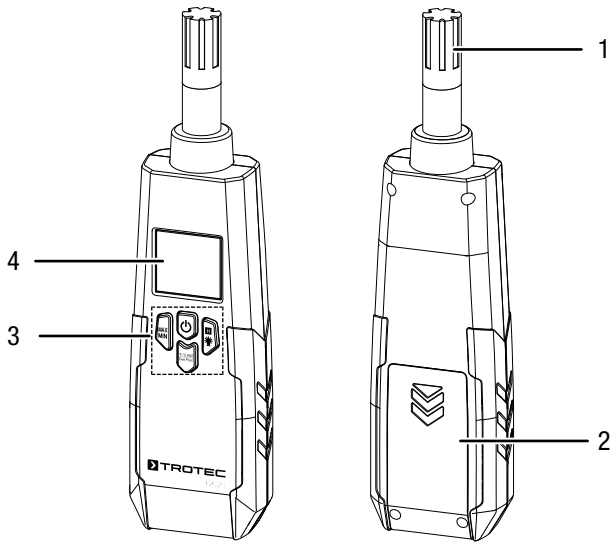

No.	Designation
1	Measuring sensor
2	Battery compartment with cover
3	Operating elements
4	Display

Operating elements

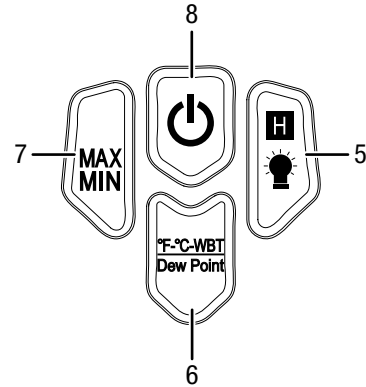

No.	Designation
5	HOLD / lamp button
6	Dew Point button
7	MAX / MIN button
8	Power button

Display

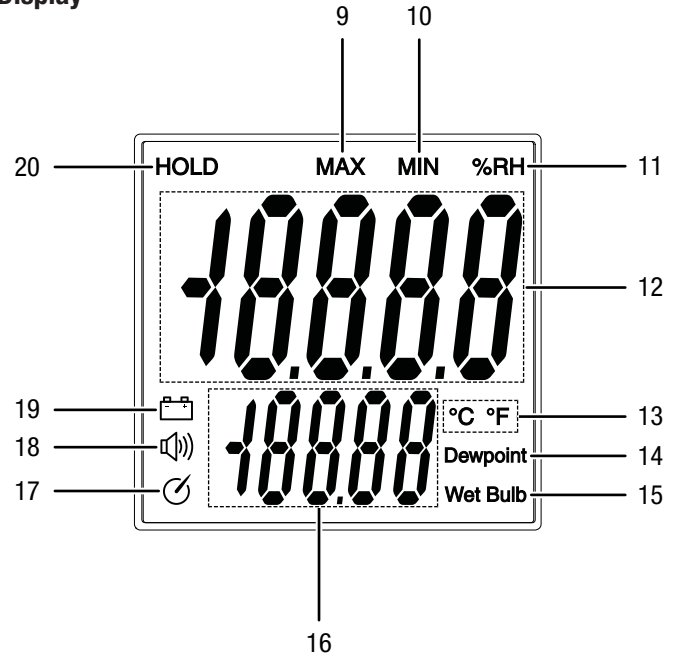

No.	Designation
9	MAX indication
10	MIN indication
11	% RH indication
12	Measurement value display
13	Temperature unit indication
14	Dew point indication
15	Wet bulb indication
16	Measurement value display bottom
17	Automatic switch-off indication
18	Alarm indication
19	Battery indication
20	HOLD indication

Technical data

Parameter	Value
Model	BC21
Weight	210 g
Dimensions (height x width x depth)	230 mm x 55 mm x 32 mm
Temperature	
Measuring range	-30 to 100 °C (-22 to 199 °F)
Accuracy	± 1 °C (± 1.5 °F)
Measuring range resolution	0.1 °C (0.1 °F)
Dew point temperature	
Measuring range:	-30 to 100 °C (-22 to 199 °F)
Accuracy	± 1 °C (± 1.5 °F)
Measuring range resolution	0.1 °C (0.1 °F)
Wet-bulb temperature	
Measuring range:	-30 to 100 °C (-22 to 199 °F)
Accuracy	± 1 °C (± 1.5 °F)
Measuring range resolution	0.1 °C (0.1 °F)
Humidity	
Measuring range:	0 to 100 % RH (specified 5 to 95 % RH)
Accuracy	± 2 % RH (at 25 °C and 5 to 95 % RH)
Measuring range resolution	0.1 % RH
General technical data	
Measuring rate	2.5 measurements per second
Response time	10 seconds (90 % RH / 25 °C calm)
Operating temperature	0 to 50 °C at < 80 % RH non-condensing
Storage temperature	-10 to 60 °C at < 80 % RH non-condensing
Power supply	1 x 9 V battery
Device switch-off	After approx. 15 minutes of non-use

Scope of delivery

- 1 x Device BC21
- 1 x 9 V battery
- 1 x Quick guide

Transport and storage

Note

If you store or transport the device improperly, the device may be damaged.

Note the information regarding transport and storage of the device.

Transport

The manufacturer packed the device to the best of his abilities to protect it against transport damage.

Storage

When the device is not being used, observe the following storage conditions:

- dry and protected from frost and heat
- protected from dust and direct sunlight
- the storage temperature complies with the values specified in the Technical data
- Remove the battery from the device.

Operation

Inserting the batteries

Note

Make sure that the surface of the device is dry and the device is switched off.

1. Open the battery compartment by sliding open the cover (2) in the direction of the arrow.
2. Remove the battery compartment cover (2).
3. Use the battery clip (21) to connect the battery (1 x 9 V) with correct polarity.
4. Insert the battery in the device.
5. Slide the battery compartment cover (2) back on the device.

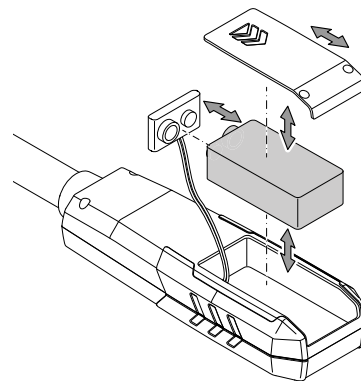

Switch-on and measurements

1. Press the *power* button (8).
 - ⇒ The display is switched on.
 - ⇒ The device is ready for operation.
2. Point the device at the area to be measured.
 - ⇒ Wait for a moment to achieve a stable measured value.

Note:

Note that moving from a cold area to a warm area can lead to condensation forming on the device's circuit board. This physical and unavoidable effect can falsify the measurement. In this case, the display shows either no measured values or they are incorrect. Wait a few minutes until the device has become adjusted to the changed conditions before carrying out a measurement.

Switching the display illumination on and off

1. Press the *HOLD / lamp* button (5) for approx. 3 seconds.
 - ⇒ The display illumination goes on.
2. Press the *HOLD / lamp* button (5) again for approx. 3 seconds.
 - ⇒ The display illumination switches off.

Setting the MAX / MIN function

1. Press the *MAX / MIN* button (7).
 - ⇒ MAX (9) appears on the display.
 - ⇒ Actuating the *MAX / MIN* button (7) starts a new measurement. The value now appearing on the display is the reference value.
 - ⇒ MAX function: The maximum value of the newly started measurement interval is displayed. Values smaller than the one displayed will not be indicated.
2. Press the *MAX / MIN* button (7) again.
 - ⇒ MIN (10) appears on the display.
 - ⇒ Actuating the *MAX / MIN* button (7) starts a new measurement. The value now appearing on the display is the reference value.
 - ⇒ MIN function: The minimum value of the newly started measurement interval is displayed. Values exceeding the one displayed will not be indicated.
3. Press the *MAX / MIN* button (7) for approx. 2 seconds to terminate the function.
 - ⇒ The measurement interval is reset.
 - ⇒ The currently measured value is indicated.

Setting the HOLD function

1. Press the *HOLD / lamp* button (5).
 - ⇒ The current value will be held.
2. Press the *HOLD / lamp* button (5) again.
 - ⇒ The display again indicates the current measured value.

Setting of the measuring functions

Here the unit for the lower measurement value display (16) can be set.

1. Press the *Dew Point* button (6).
 - ⇒ The displayed unit (13, 14, 15) changes.
 - ⇒ Possible display values are:

Unit	Description
°C	Temperature indication in degrees Celsius
°F	Temperature indication in degrees Fahrenheit
Wet Bulb	Indication of the wet-bulb temperature
Dew Point	Indication of the dew point temperature

Switch-off

1. Press the *power* button (8).
 - ⇒ The device will be switched off.

Maintenance and repair

Battery change

A battery change is required when a *battery* indication (19) lights up on the display (4) or the device can no longer be switched on. See chapter Operation.

Cleaning

Clean the device with a soft, damp and lint-free cloth. Make sure that no moisture enters the housing. Do not use any sprays, solvents, alcohol-based cleaning agents or abrasive cleaners, but only clean water to moisten the cloth.

Repair

Do not modify the device or install any spare parts. For repairs or device testing, contact the manufacturer.

Disposal

Always dispose of packing materials in an environmentally friendly manner and in accordance with the applicable local disposal regulations.



The icon with the crossed-out waste bin on waste electrical or electronic equipment is taken from Directive 2012/19/EU. It states that this device must not be disposed of with the household waste at the end of its life. You will find collection points for free return of waste electrical and electronic equipment in your vicinity. The addresses can be obtained from your municipality or local administration. You can also find out about other return options that apply for many EU countries on the website <https://hub.trotec.com/?id=45090>. Otherwise, please contact an official recycling centre for electronic and electrical equipment authorised for your country.

The separate collection of waste electrical and electronic equipment aims to enable the re-use, recycling and other forms of recovery of waste equipment as well as to prevent negative effects for the environment and human health caused by the disposal of hazardous substances potentially contained in the equipment.



In the European Union, batteries and accumulators must not be treated as domestic waste, but must be disposed of professionally in accordance with Directive 2006/66/EC of the European Parliament and of the Council of 6 September 2006 on batteries and accumulators. Please dispose of batteries and accumulators according to the relevant legal requirements.

Only for United Kingdom

According to Waste Electrical and Electronic Equipment Regulations 2013 (SI 2013/3113) (as amended) and the Waste Batteries and Accumulators Regulations 2009 (SI 2009/890) (as amended), devices that are no longer usable must be collected separately and disposed of in an environmentally friendly manner.

Trotec GmbH

Grebener Str. 7
D-52525 Heinsberg

☎ +49 2452 962-400

☎ +49 2452 962-200

✉ info@trotec.com

www.trotec.com